

Intelligent LED Driver (Constant Voltage)

- Small size and light weight. The housing is made from V0 flame retardant PC materials that SAMSUNG/COVESTRO uses.
- The clamshell design and screwless type for strain-relief. The design of dismountable end cap allows you to adjust the length of housing depending on your needs.
- With soft-on and fade-in dimming function, enhancing your visual comfort.
- Dimming from 0~100%, down to 0.1%.
- Support Leading edge (Triac), Trailing edge (ELV) and Push DIM.
- Innovative thermal management technology intelligently protects the power life.
- Overheat, over voltage, overload, short circuit protection and automatic recovery.
- Suitable for indoor light applications of I/II/III type.
- Up to 50,000-hour life time.
- 5-year warranty (Rubycon capacitor).



Flicker-Free
IEEE 1789

Dimmable:
0.1%~100%



Use only within an enclosure.



The certification icon represents on-going certification applications only, and final certification qualification is subject to actual products.



Technical Specs

Model		LM-36-24-L1T2	LM-36-12-L1T2	
OUTPUT	Output Voltage	24Vdc	12Vdc	
	Output Voltage Range	24Vdc±0.5Vdc	12Vdc±0.5Vdc	
	Output Current	Max. 1.5A	Max. 3A	
	Output Power	Max. 36W		
	Output Power Range	0-36W		
	Strobe Level	High frequency exemption level		
	Dimming Range	0~100%, down to 0.1%		
	Overload Power Limitation	≥102%		
	Ripple	≤200mV		
PWM Frequency	3600Hz			
INPUT	Dimming Interface	Triac/ELV, Push DIM		
	Input Voltage	108-132Vac		
	Frequency	50/60Hz		
	Input Current	≤0.4A/120Vac		
	Power Factor	PF>0.98/120Vac (at full load)		
	THD	THD<6%/120Vac (at full load)		
	Efficiency (typ.)	84%		
	Standby Power Loss	<0.5W		
	Inrush Current	Cold start 25A(Test twidth=204us under 50% Ipeak)@120Vac		
	Anti Surge	L-N: 2KV		
	Leakage Current	Max. 0.5mA		
ENVIRONMENT	Working Temperature	ta: -20~50°C tc: 90°C		
	Working Humidity	20-95%RH, non-condensing		
	Storage Temperature, Humidity	-40~80°C, 10-95%RH		
	Temperature Coefficient	±0.03%/°C(-20~50°C)		
	Vibration	10~500Hz, 2G 12min/1cycle, 72 min for X, Y and Z axes respectively		
PROTECTION	Overheat Protection	Intelligently adjust or turn off the output current if the PCB temperature ≥110°C, and recover automatically		
	Overload Protection	Shut down the output when current loads ≥102%, and recover automatically		
	Short Circuit Protection	Enter hiccup mode if short circuit occurs, and recover automatically		
	Overvoltage Protection	Shut down the output when non-load voltage ≥26V, and recover automatically	Shut down the output when non-load voltage ≥13V, and recover automatically	
SAFETY & EMC	Withstand Voltage	I/P-O/P: 3750Vac		
	Isolation Resistance	I/P-O/P: 100MΩ/500VDC/25°C/70%RH		
	Safety Standards	UL	America	UL8750
		CUL	Canada	CSA C22.2 NO. 250. 13
		CE	European Union	EN61347-1, EN61347-2-13, EN62384
	EMC Emission	UL	America	FCC part 15
		CE	European Union	EN55015, EN61000-3-2, EN61000-3-3, EN61547
EMC Immunity	EN61000-4-2,3,4,5,6,8,11, EN61547			
Strobe Test Standard	IEEE 1789			
OTHERS	Gross Weight(G.W)	210g±10g		
	Dimensions	210×43×30mm(L×W×H)		
	Package Size	213×44×33mm(L×W×H)		
	Carton Size	440×218×235mm(L×W×H) 60pcs/ctn 13.4kg±5%/ctn		

The driver is suitable for connecting resistor current-limiting LED fixture (e.g. LED strip). The inrush current will be dozens of times increased if connecting built-in constant current IC current-limiting LED fixtures, the driver will activate the overloaded protection (hiccup flickering). When you order, please remark controlling the constant current LED fixture (e.g. MR16 lamp, underground light, LED wall washer, constant current LED strip, etc.), so that we can prepare them with special procedures.

Product Size

Unit: mm

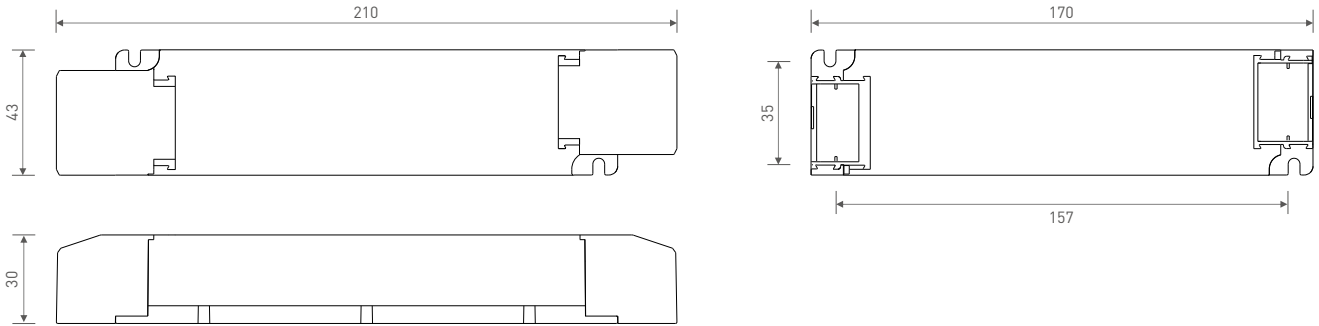

Wiring Diagram

Triac/ELV Connection



Push DIM Connection

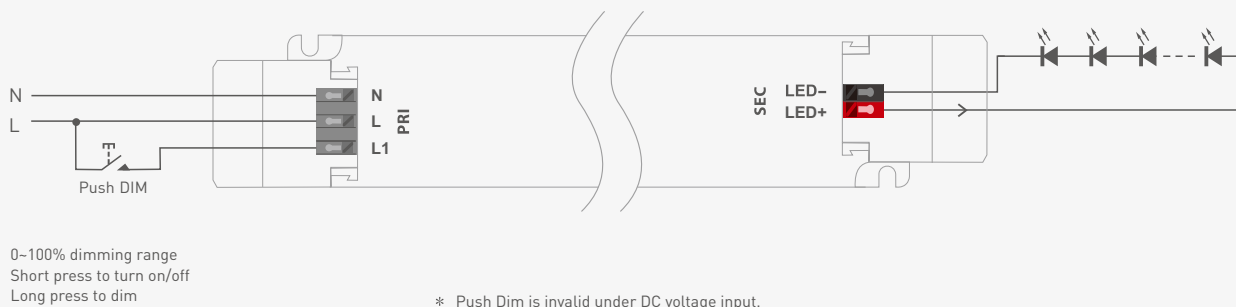

Push DIM



Reset switch

- On/off control: Short press.
- Stepless dimming: Long press.
- With every other long press, the brightness level goes to the opposite direction.
- Dimming memory: Dimming memory: Short press the PUSH DIM button, the brightness will go to the the previously adjusted level.
Power on again after power cut, the output brightness will be adjusted in accordance with the input voltage of drivers.

Protective Housing Application Diagram

Tension plate

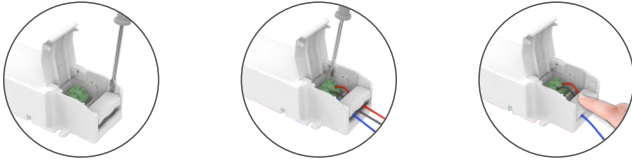

1. Pry up the protecting housing in the side plate position with a tool.
2. Connect to electrical wires with a screwdriver as wiring diagram shows.
3. Press down the tension plate to fix the the electrical wires, then close the protective housing.

Remove the protective housing



Pull the housing left and right from the bottom to remove it.

Installation Precautions

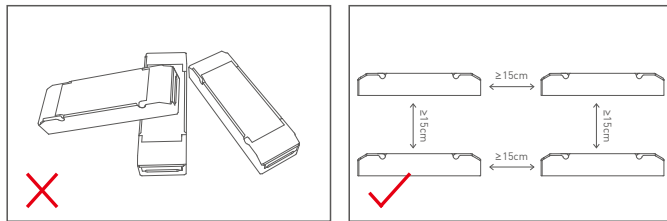

Please do not stack the products. The distance between two products should be $\geq 15\text{cm}$ so as not to affect heat dissipation and the lifespan of the products.

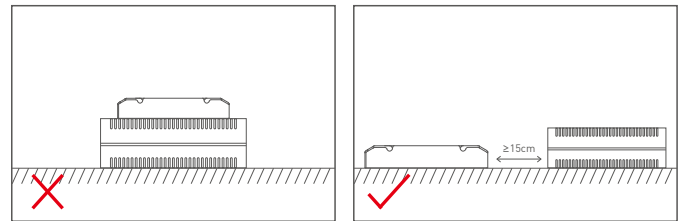

Please not place the products on LED drivers. The distance between the product and the driver should be $\geq 15\text{cm}$ so as not to affect heat dissipation and shorten the lifespan of the products.

Relationship Diagrams

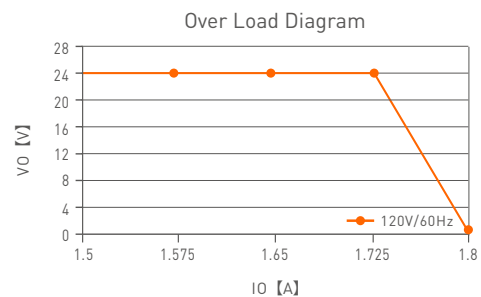
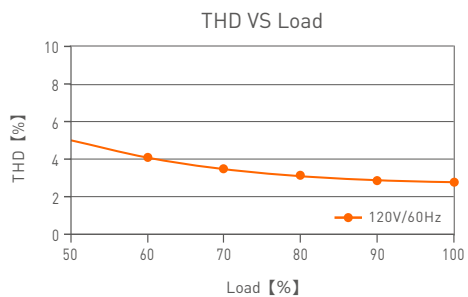
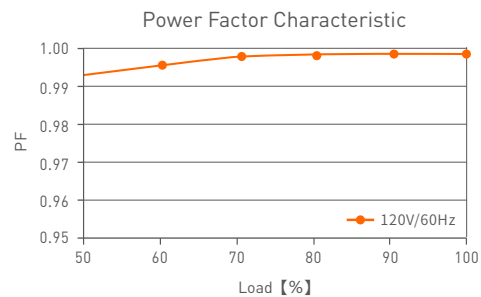
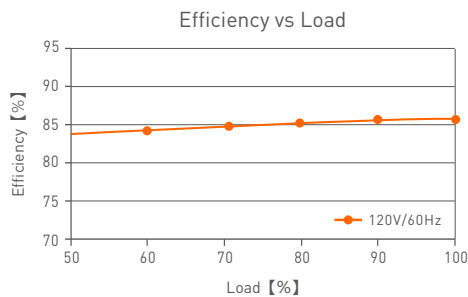

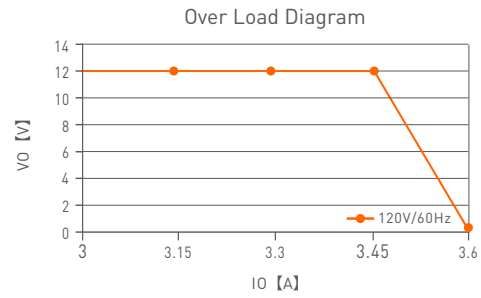
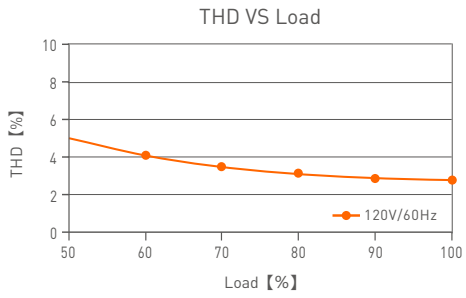
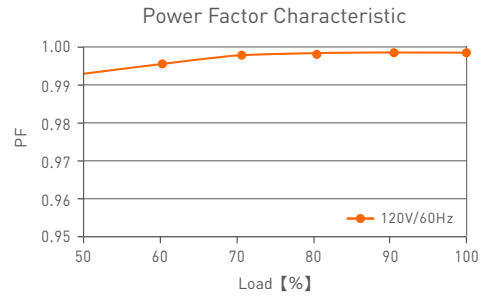
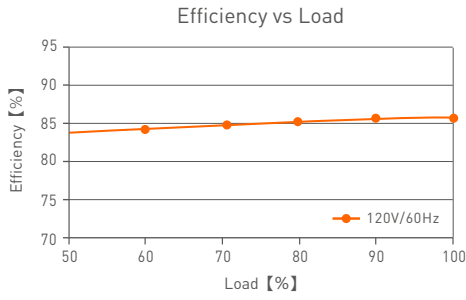

LM-36-12-L1T2

Flicker Test Table

Limit Value of Modulation in Low Risk Areas	
Waveform frequency of Optical output (f)	Limit value (%)
$f \leq 8\text{Hz}$	0.2
$8\text{Hz} < f \leq 90\text{Hz}$	$0.025 \times f$
$90\text{Hz} < f \leq 1250\text{Hz}$	$0.08 \times f$
$f > 1250\text{Hz}$	Exemption assessment
Limit Value of Modulation in No Effect Areas	
Waveform frequency of Optical output (f)	Limit value (%)
$f \leq 10\text{Hz}$	0.1
$10\text{Hz} < f \leq 90\text{Hz}$	$0.01 \times f$
$90\text{Hz} < f \leq 3125\text{Hz}$	$[0.08/2.5] \times f$
$f > 3125\text{Hz}$	Exemption assessment (High frequency exemption)

Brightness

- ▲ 0.1%
- ◆ 1%
- ◆ 5%
- ◆ 10%
- 20%
- ◆ 30%
- 40%
- ★ 50%
- 60%
- 70%
- ◆ 80%
- ★ 90%
- ◆ 100%

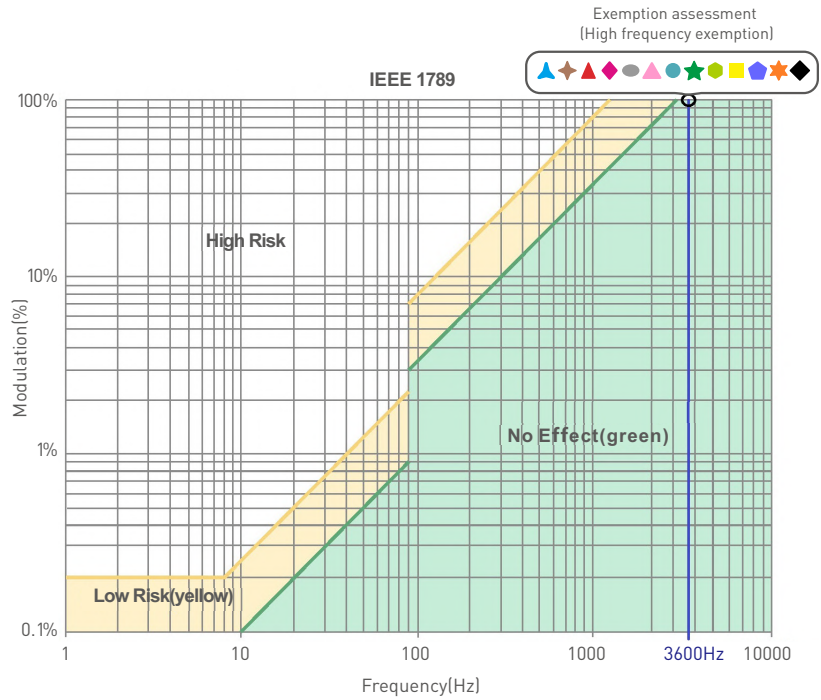

Marks in the right chart are tested results of different current levels. The output frequency is 0Hz in 100% brightness and its corresponding modulation is 0%, which could not be shown in the right chart.

Attentions

- Products shall be installed by qualified professionals.
 - LTECH products are non-waterproof (special models excepted). Please avoid the sun and rain. When installed outdoors, please ensure it is mounted in a water proof enclosure.
 - Good heat dissipation will extend the working life of products. Please ensure good ventilation.
 - Please check if the working voltage used complies with the parameter requirements of products.
 - The diameter of wire used must be able to load the light fixtures you connect and ensure the firm wiring.
 - Before you power on products, please make sure all the wiring is correct in case of incorrect connection that causes damage to light fixtures.
 - If a fault occurs, please do not attempt to fix products by yourself. If you have any question, please contact your suppliers.
- * This manual is subject to changes without further notice. Product functions depend on the goods. Please feel free to contact our official distributors if you have any question.

Warranty Agreement

- Warranty periods from the date of delivery: 5 years.
- Free repair or replacement services for quality problems are provided within warranty periods.

Warranty exclusions below:

- Beyond warranty periods.
- Any artificial damage caused by high voltage, overload, or improper operations.
- Products with severe physical damage.
- Damage caused by natural disasters and force majeure.
- Warranty labels and barcodes have been damaged.
- No any contract signed by LTECH.

1. Repair or replacement provided is the only remedy for customers. LTECH is not liable for any incidental or consequential damage unless it is within the law.
2. LTECH has the right to amend or adjust the terms of this warranty, and release in written form shall prevail.

Update Log

Version	Updated Time	Update Content	Updated by
A0	2021.06.18	Original version	Liu Weili
A1	2021.12.10	Update product silk screen	Liu Weili
A2	2022.04.29	Update protective housing application diagram	Liu Weili

LED智能调光驱动器 (恒压型)

- 体积小、重量轻;外壳采用科思创/三星PC阻燃V0级原料
- 免螺丝压线翻盖设计,可拆卸端盖,按需调节壳体长度
- 带软启动渐亮功能,让人眼视觉更舒服
- 调光范围0~100%,LED从0.1%开始调光
- 前沿(Triac),后沿(ELV)切相和Push DIM
- 信号光电隔离设计,更加安全可靠
- 创新的热管理技术,智能保护电源寿命
- 短路、过温、过载、过压保护,可自动恢复
- 适合室内 I、II、III类灯具应用
- 高达50,000小时的额定寿命
- 5年保修期(采用红宝石电容)

无频闪
IEEE 1789

Dimmable:
0.1%~100%

cULus
Type TL 85/80.6°C
Use only within an enclosure.

FC

CE

RoHS

SELV

Class 2



认证图标仅代表产品正在进行一系列的认证申请,认证资质以产品实物为准。



技术参数

型号		LM-36-24-L1T2	LM-36-12-L1T2	
输出	输出电压	24Vdc	12Vdc	
	输出电压范围	24Vdc ± 0.5Vdc	12Vdc ± 0.5Vdc	
	输出电流	Max. 1.5A	Max. 3A	
	输出功率	Max. 36W		
	输出功率范围	0~36W		
	频闪级别	高频豁免考核级别		
	调光范围	0~100%, 调光深度: Max. 0.1%		
	过载功率限制	≥102%		
	纹波	≤200mV		
	PWM调光频率	3600Hz		
输入	调光接口	前沿Triac/后沿ELV切相, Push DIM		
	输入电压	108-132Vac		
	频率范围	50/60Hz		
	输入电流	≤0.4A/120Vac		
	功率因素	PF>0.98/120Vac (满载)		
	谐波THD	THD<6%/120Vac (满载)		
	效率 (Typ.)	84%		
	浪涌电流	冷启动, 25A(在50% Ipeak下测试twidth=204us)@120Vac		
	抗浪涌	L-N: 2kV		
	漏电流	Max. 0.5mA		
环境	工作温度	ta: -20 ~ 50°C tc: 90°C		
	工作湿度	20 ~ 95%RH, 无冷凝		
	储存温度/湿度	-40°C ~ 80°C, 10~95%RH		
	温度系数	±0.03%/°C(-20°C ~ 50°C)		
	耐振动	10-500HZ, 2G 12分钟/周期, X, Y, Z轴各72分钟		
保护	过温保护	根据PCB温度超标情况(≥110°C), 智能调节电流输出或关闭, 可自动恢复		
	过载保护	负载电流≥102%, 关闭输出, 可自动恢复		
	短路保护	输出线路短路自动关闭, 可自动恢复		
	过压保护	空载电压≥26V关闭输出, 异常排除后上电恢复	空载电压≥13V关闭输出, 异常排除后上电恢复	
安规和电磁规格	耐压	输入对输出: 3750Vac		
	绝缘阻抗	输入对输出: 10MΩ/500Vdc/25°C/70%RH		
	安全规范	UL	美国	UL8750
		CUL	加拿大	CSA C22.2 No. 250.13
		CE	欧盟	EN61347-1, EN61347-2-13, EN62384
	电磁兼容发射	UL	美国	FCC part 15
		CE	欧盟	EN55015, EN61000-3-2, EN61000-3-3, EN61547
电磁兼容抗扰度	EN61000-4-2,3,4,5,6,8,11, EN61547			
频闪测试	IEEE 1789			
其他	产品重量	210g±10g		
	产品尺寸	210x43x30mm(L×W×H)		
	包装尺寸	213x44x33mm(L×W×H)		
	外箱规格	440x218x235mm(L×W×H) 60个/箱 13.4kg±5%/箱		

* 本款驱动器适合连接电阻限流的LED灯具(如LED灯条)。如果连接内置恒流IC限流的灯具,会产生几十倍的瞬间浪涌电流,导致驱动器会执行过载保护(打嗝频闪)。下单时这类内置恒流IC限流的灯具需要注明(如MR16灯杯、地埋灯、洗墙灯、恒流硬灯条等),以便烧写特殊程序。

尺寸图

单位: mm

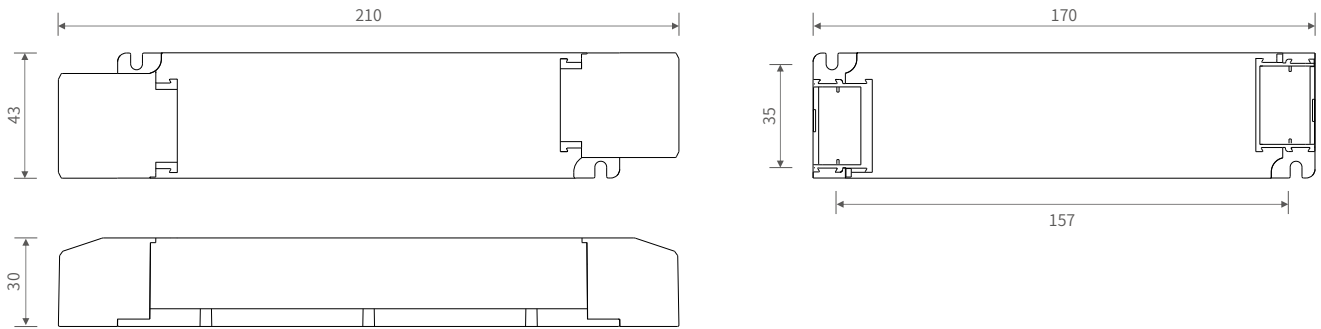

连接应用图

Triac 连接方式



Push DIM 连接方式



Push DIM



复位开关

- 开关控制: 短按.
- 无级调光: 长按.
- 每隔一次长按, 亮度会向相反方向调整.
- 调光记忆: 短按PUSH DIM按键开关时, 灯光会回到先前调整的亮度值; 断电后再上电, 灯光按照输入驱动电源电压调整输出亮度值。

保护盖应用图

压线板

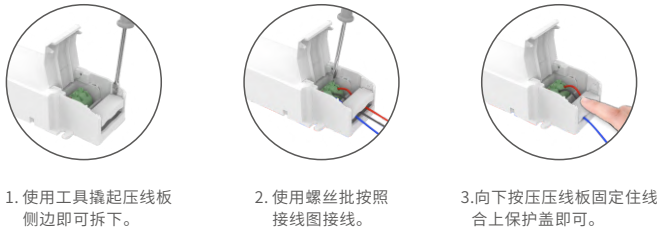

保护盖的拆装

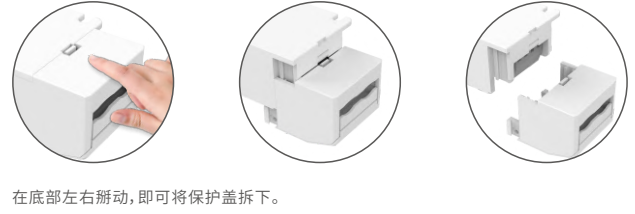

安装注意事项

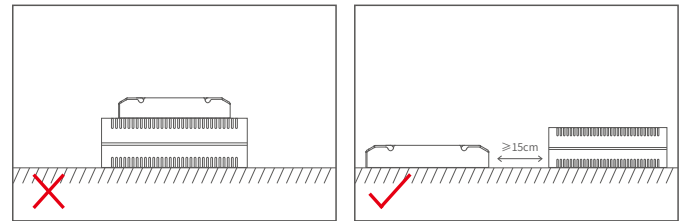
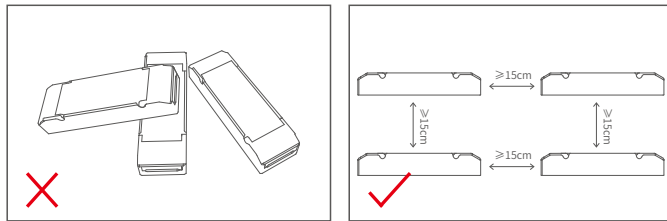

关系图表

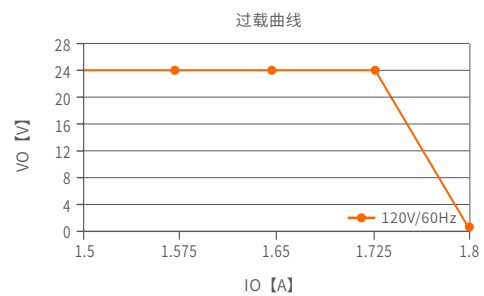
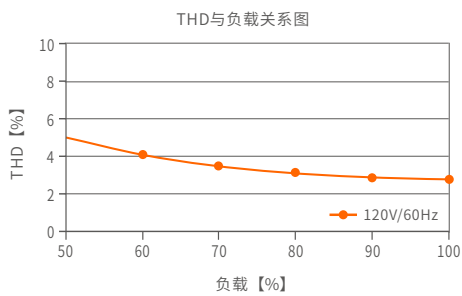
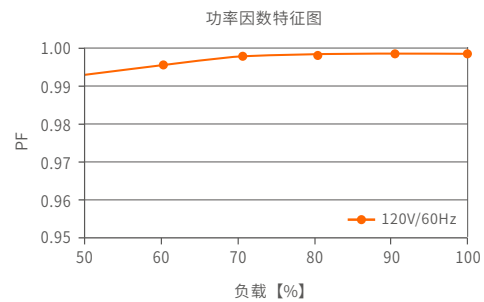
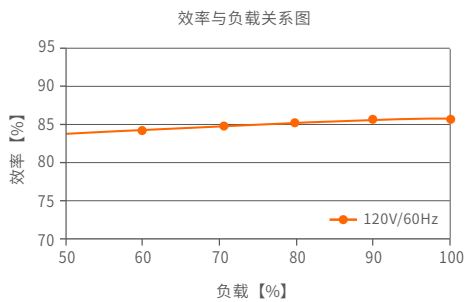

LM-36-24-L1T2

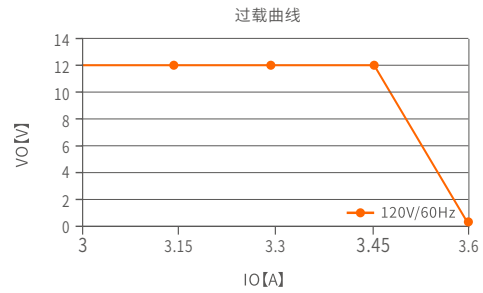
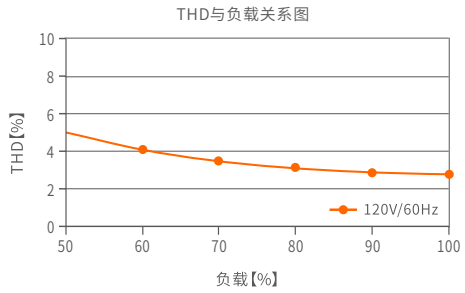
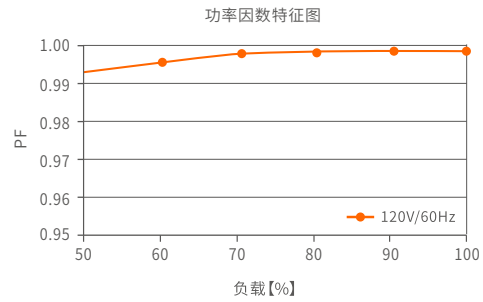
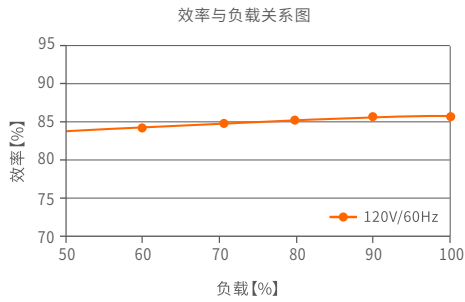

LM-36-12-L1T2

频闪测试表

IEEE 1789

低风险区域 (Low Risk) 的波动深度 (Modulation) 限值	
光输出波形频率 (f)	限值 (%)
$f \leq 8\text{Hz}$	0.2
$8\text{Hz} < f \leq 90\text{Hz}$	$0.025 \times f$
$90\text{Hz} < f \leq 1250\text{Hz}$	$0.08 \times f$
$f > 1250\text{Hz}$	免除考核
无风险区域 (No Effect) 的波动深度 (Modulation) 限值	
光输出波形频率 (f)	限值 (%)
$f \leq 10\text{Hz}$	0.1
$10\text{Hz} < f \leq 90\text{Hz}$	$0.01 \times f$
$90\text{Hz} < f \leq 3125\text{Hz}$	$(0.08/2.5) \times f$
$f > 3125\text{Hz}$	免除考核(高频豁免)

- 亮度
- ▲ 0.1%
 - ▲ 1%
 - ▲ 5%
 - ▲ 10%
 - 20%
 - ▲ 30%
 - 40%
 - ★ 50%
 - 60%
 - 70%
 - 80%
 - ★ 90%
 - ◆ 100%

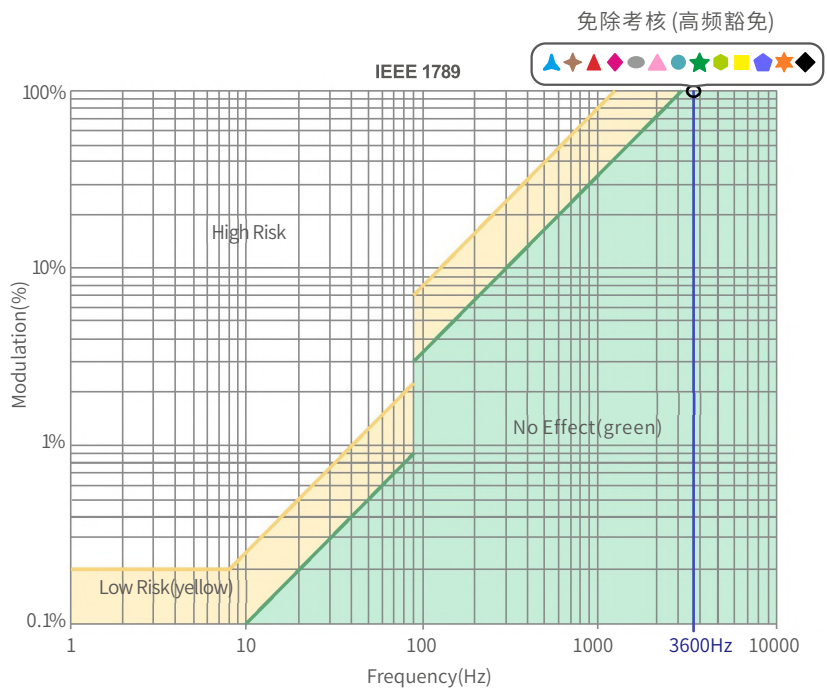

右图标识为不同电流档的测试结果。

100%亮度时输出频率为0Hz, 对应波动深度为0%, 无法在右图中示意。

注意事项

- 请由具有专业资格的人员进行调试安装;
- 雷特产品(专有型号除外)不能防水,需避免日晒雨淋,如安装在户外,请用防水箱;
- 良好的散热条件会延长产品的使用寿命,请把产品安装在通风良好的环境;
- 请检查使用的工作电压是否符合产品的参数要求;
- 使用的电线直径大小必须能够负载连接的LED灯具,并确保接线牢固;
- 通电调试前,应确保所有接线正确,以避免因接线错误而导致灯具损坏;
- 如果发生故障,请勿私自维修;如有疑问,请联系供应商。

* 本说明书的内容如有变更,恕不另行通知。若内容与您使用的功能有所不同,则以实物为准。如有疑问,欢迎向我司授权的经销商咨询。

保修条例

- 自出厂之日起保修服务期为5年。
- 在保修服务期内出现产品质量问题雷特将给予免费修理或更换服务。

非保修条例:

属下列情况不在免费保修或更换服务范围之内:

- 已经超出保修服务期;
- 过高电压、超负载、操作不当等人为造成的损坏;
- 产品外形严重损坏或变形;
- 自然灾害以及人力不可抗拒原因造成的损坏;
- 产品保修标签和产品唯一条形码损坏;
- 无雷特签订的合同或发票凭证。

1. 修理或更换是雷特对客户的一补救措施。雷特不承担任何附带引起的损害赔偿,除非在适用法律范围之内。
2. 雷特享有修正或调整本保修条款的权利,并以书面形式发布为准。

更新日志

版本	更改日期	更改内容	更改人
A0	2021.04.23	正稿	刘伟丽
A1	2021.12.10	更新产品丝印	刘伟丽
A2	2022.04.29	更新保护盖应用图	刘伟丽