

# LTECH

## GAM-BLE Wireless Module

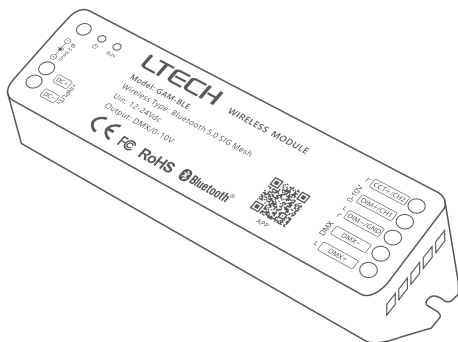

## Manual

For more information, please visit our website  
[www.ltech-led.com](http://www.ltech-led.com)

# System Diagram

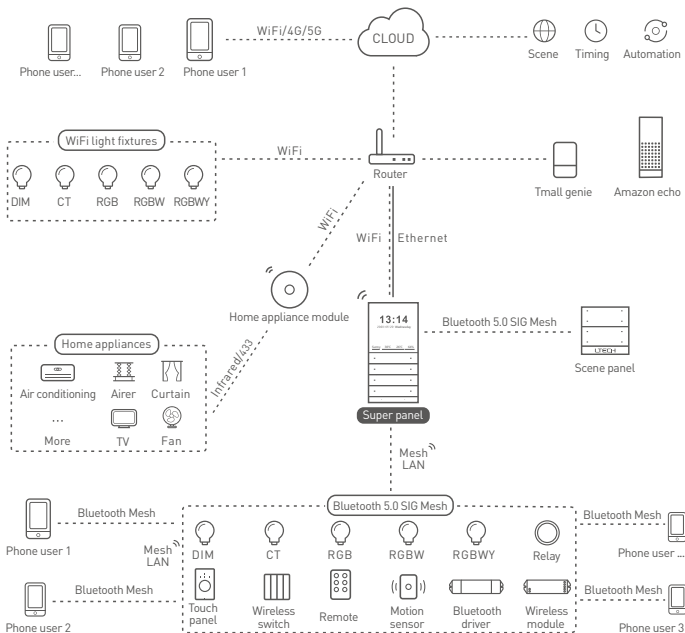

## Product Characteristics

- Small size and light weight. Adopt SAMSUNG/COVESTRO V0 flame resistant polycarbonate protective housings.
- Bluetooth 5.0 SIG Mesh with high networking capability is reliable and stable.
- Support direct control on iOS or Android devices through Bluetooth connection.
- Support remote, wireless panel switch and group control over LAN without connecting a gateway.
- Work with the Super Panel to achieve remote control.
- With soft-on and fade-in dimming function enhancing your visual comfort.
- 0-100% dimming range, down to 0.1%.
- Covert Bluetooth signal to 0-10V signal, and connect to 0-10V dimmable drivers to control DIM/CT.
- Covert Bluetooth signal to DMX signal, and connect to DMX dimmable drivers to control DIM/CT/RGB/RGBW/RGBWY.
- Adding a super tool allows you to set up soft start gradient time, lighting status after lights being power-on, and dimming curves.

## Technical Specs

Model	GAM-BLE
Wireless Protocol Type	Bluetooth 5.0 SIG Mesh
Output Signal	0-10Vx2CH / DMX
Working Voltage	12 ~ 24Vdc
Wireless Spectrum	2.4GHZ
Working Temperature	-20°C ~ 55°C
Working Humidity	20 ~ 95%RH, non-condensing
Protection	Anti reverse connection
Dimensions	125×33×20mm(L×W×H)
Package Size	127×35×22mm(L×W×H)
Weight(G. W.)	60g

## Diagram

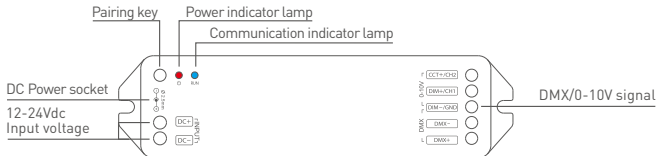

- \* Long press the pairing key for 6s and the communication indicator lamp flashes blue, which means the device has been reset to factory defaults and gets into the network configuration mode again.

## Product Size

Unit: mm

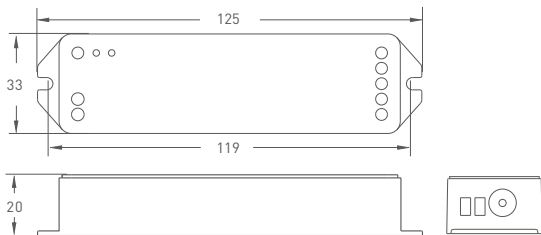

## Recommend Applications

1. Link up the wireless module (BLE to 0-10V) by App to achieve fast dimming control.



APP

+

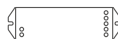

Wireless module  
(BLE to 0-10V)



0-10V Driver  
(DIM/CT)



Lamp

2. Link up the wireless module (BLE to DMX) by App to achieve fast dimming control.

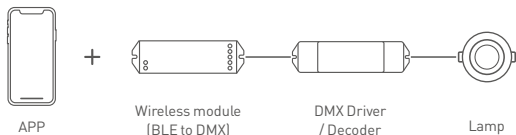

3. Link up the Super Panel with the wireless module by App to realize visual control + remote control of traditional panels.

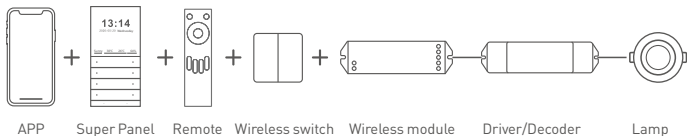

4. Link up the intelligent touch panel with the wireless module by App to control the lamp simultaneously by App, Super Panel and touch panel.

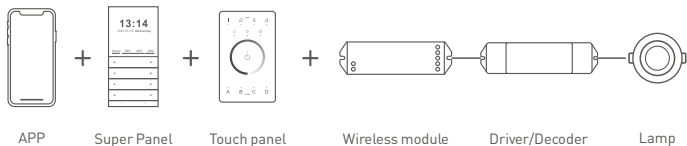

5. ....More applications of intelligent control are waiting for you to set up.

## DMX Wiring Diagram

### DIM

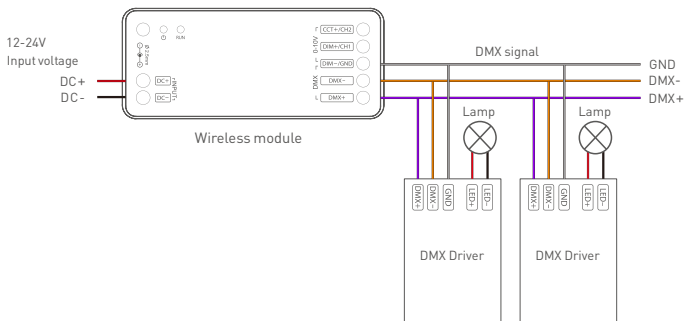

### CT

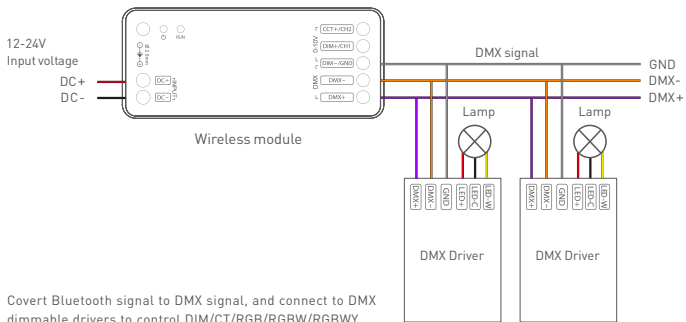

Convert Bluetooth signal to DMX signal, and connect to DMX dimmable drivers to control DIM/CT/RGB/RGBW/RGBWY.

## 0-10V Wiring Diagram

DIM

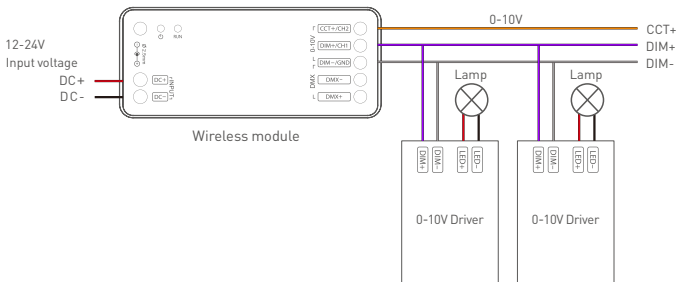

CT

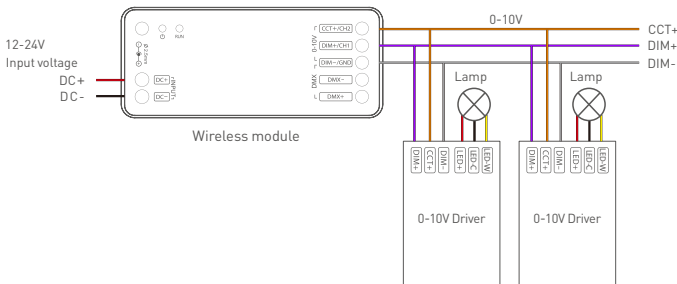

## App Operating Instructions

### 1. Register an account

Scan the QR code below with your mobile phone and follow the prompts to complete the App installation. Open the App and log in or register an account.



APP

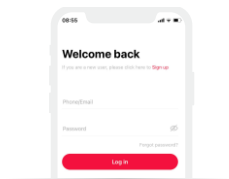

### 2. Pairing instructions

Create a home if you are a new user. Click "+" icon in the upper right corner and access "Add Device" list. Pick "Smart Lighting" from "Add Device" list to select the light fixture type you want to add. Click "Bluetooth Search" to add the device (Make sure the device is powered on and not connected to network). When you have already searched the device , click "+" icon to add it. Rename the device and select the room it belongs to, then click "Confirm" and you'll successfully add the device.

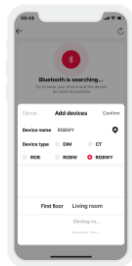
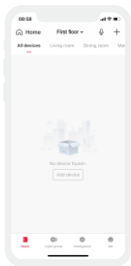



### 3. Control interface settings

After pairing up your device, go to the control interface. You'll be able to achieve your desired lighting effects by changing brightness, colors and color temperature. Click "Theme" and you'll easily switch to multiple theme lighting effects with one tap. Click "Mode" and the App provides you editable normal modes and editable advanced modes. Customize dynamic modes to put you into a more colorful life.

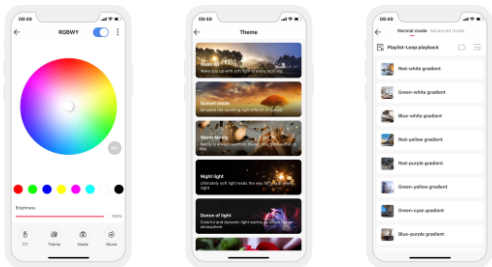

### 4. Light groups

Users are able to combine the same type of light fixtures into a group to control them simultaneously. Once you create the group, you can set the dim level or change colors of lights more easily. Switch to "Group" menu and click "+" icon in the upper right corner. Follow the prompts to rename the group and click "Next" to pick the lights you are going to group together and to save them.

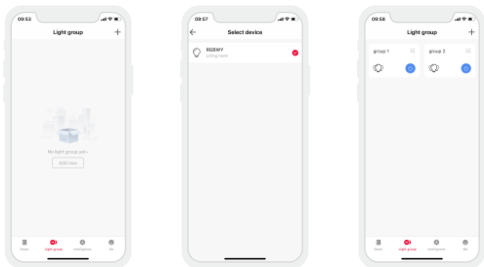

## 5. Advanced functions

This module can be linked up with gateway devices (such as LTECH Super Panel) to achieve the advanced functions from cloud scenes to automation.

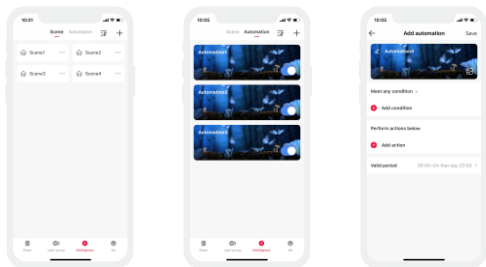

## How to Reset the Device (Reset to Factory Defaults)

Method 1(Recommended): Go to the App settings and click "Delete Device". When the lamp flashes 5 times, the device will exit the network successfully.

Method 2: Long press the pairing key for 6s. When the lamp flashes 5 times, the device will exit the network successfully. This method is to force exit the network and is for abnormal condition use.

Method 3: Make sure the driver is well-connected to a lamp and the lamp is on, turn it off with the switch and after 15s turn it on. After 2s, turn it off again. Repeat the same operation 6 times. When the lamp flashes 5 times , reset the device to factory defaults successfully.

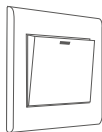

Turn it on 2s



Turn it off 15s

Under the driver being power-on

Turn it off — 15s — Turn it on — 2s — .....

(Repeat 6 times)

## Attentions

- Products shall be installed by qualified professionals.
- LTECH products are non-waterproof (special models excepted). Please avoid the sun and rain. When installed outdoors, please ensure it is mounted in a water proof enclosure.
- Good heat dissipation will extend the working life of products. Please ensure good ventilation.
- Please check if the working voltage used complies with the parameter requirements of products.
- The diameter of wire used must be able to load the light fixtures you connect and ensure the firm wiring.
- Before you power on products, please make sure all the wiring is correct in case of incorrect connection that causes damage to light fixtures.
- If a fault occurs, please do not attempt to fix products by yourself. If you have any question, please contact your suppliers.

\* This manual is subject to changes without further notice. Product functions depend on the goods. Please feel free to contact our official distributors if you have any question.

## Warranty Agreement

- Warranty periods from the date of delivery: 2 years.
- Free repair or replacement services for quality problems are provided within warranty periods.

Warranty exclusions below:

- Beyond warranty periods.
  - Any artificial damage caused by high voltage, overload, or improper operations.
  - Products with severe physical damage.
  - Damage caused by natural disasters and force majeure.
  - Warranty labels and barcodes have been damaged.
  - No any contract signed by LTECH.
1. Repair or replacement provided is the only remedy for customers. LTECH is not liable for any incidental or consequential damage unless it is within the law.
  2. LTECH has the right to amend or adjust the terms of this warranty, and release in written form shall prevail.