

LTECH

DMX512 DECODER

LT-903-DIP

3
CHANNELS

2 kinds of DMX interfaces

Short circuit / Over current /
Overheat protection



Photoelectric
isolation



www.ltech-led.com

Product introduction

1. Designed with 3 channels output, and Max. 8A current per channel, up to 576W output power.
2. 3-pin XLR, RJ45 DMX interface with photoelectric isolation, improve signal transmission efficiency and anti-interference ability.
3. With RDM remote management protocol, the operations can be completed via the RDM master console, such as parameters browsing & settings, DMX address settings, equipment recognition, etc.
4. With short circuit, over current and overheat protection, as well as warning function when a fault occurs.



3-pin XLR



RJ45



Photoelectric
isolation



RDM



Short circuit
protection



Overheat
protection



Over current
protection



Technical specs

Model:	LT-903-DIP
Input signal:	DMX512/RDM
DMX interfaces:	3-pin XLR, RJ45
Input voltage:	12~24Vdc
Current load:	8A × 3CH Max. 24A
Output power:	(0~96W...192W) × 3CH Max. 576W
Photoelectric isolation:	Yes
Protection:	Short circuit / Overheat / Over current protection, recover automatically.
Working temperature:	-30°C~65°C
Dimensions:	122×110×37mm(L×W×H)
Package size:	127×123×41mm(L×W×H)
Weight (G.W.):	550g

Product size

Unit: mm

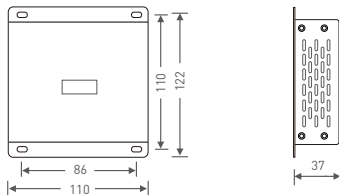

Main component description

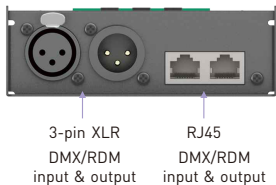
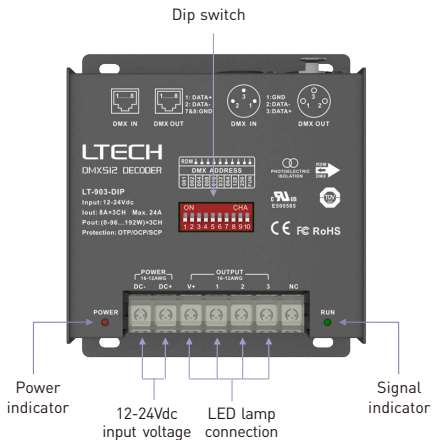

DIP switch



RDM mode: The DIP switch 1-10 are OFF.

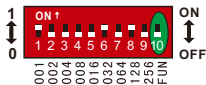

DMX mode: FUN=OFF (the 10th DIP switch = OFF)
Setting DMX addresses with dip switch 1-9

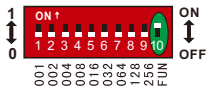

Self-testing mode: FUN=ON (the 10th DIP switch = ON)

How to set DMX address via DIP switch:

FUN=OFF (the 10th DIP switch=OFF) **DMX mode**

DMX address value = the total value of (1-9), to get the place value when in "on" position, otherwise will be 0.

E.g.1: Set initial address to 32.

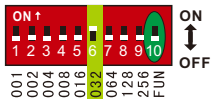

E.g.2: Set initial address to 37.

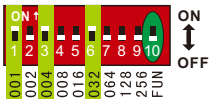

E.g.3: Set initial address to 178.



$$001+004+032=37$$

$$002+016+032+128=178$$

* When DIP switch 1-9 are OFF, the defaulted initial DMX address is 1.

Self-testing mode

FUN=ON (the 10th dip switch=ON)

Self-testing mode

DIP switch	1-9=off	1=on	2=on	3=on	4=on	5=on	6=on	7=on	8=on	9=on
Self-test function	Static black	Static red	Static green	Static blue	Static yellow	Static purple	Static cyan	Static white	7 color jumping	7 color gradient

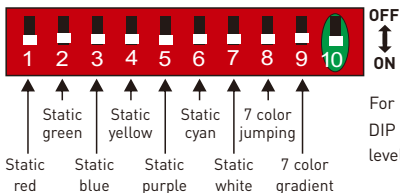

For changing effects (DIP Switch 8/9=on):
DIP switch 1-7 is used to realize 7 speed levels. (7=on, the fastest level)

[Attn] When several DIP switches are on, subjected to the highest switch value.

As the figure above shows, the effect will be 7 color gradient at 7 speed level.

DMX dimming instruction

Each LT-903-DIP DMX decoder occupied 3 DMX addresses when connecting the DMX console.

E.g., the defaulted initial address is 1, please find their corresponding relationships in the form.

DMX Console	DMX Decoder
CH1 0-255	CH1 PWM 0-100% (LED R)
CH2 0-255	CH2 PWM 0-100% (LED G)
CH3 0-255	CH3 PWM 0-100% (LED B)

Wiring diagram

1 Connecting LED lights:

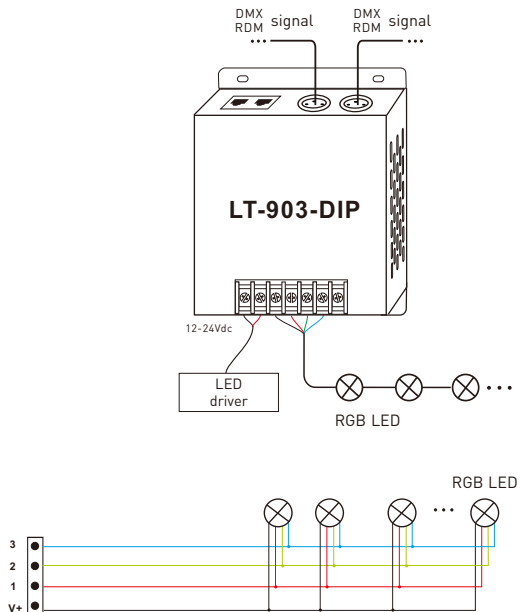

2. DMX console connection:

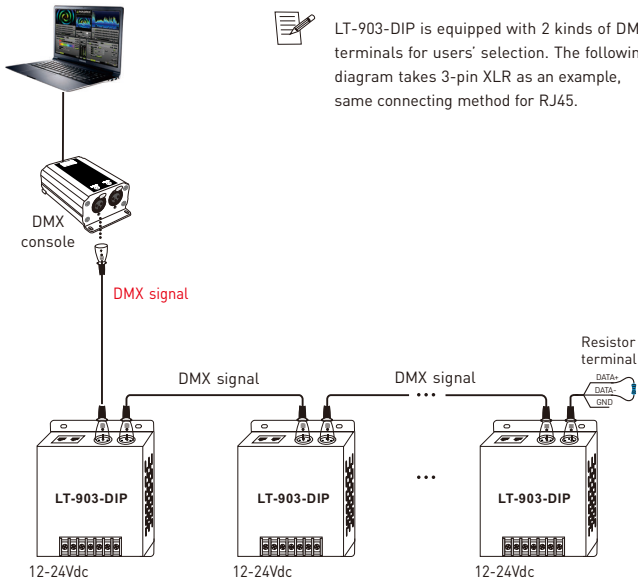

- * An amplifier is needed if more than 32 decoders are connected or use overlong signal line, signal amplification should not be more than 5 times continuously.
- * If the recoil effect occurs because of longer signal line or bad line quality, please try to connect 0.25W 90-120Ω terminal resistor at the end of each line.

3. The connection diagram of 2 kinds of DMX/RDM terminals:

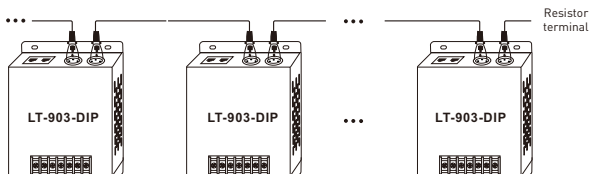

3-pin XLR connected in parallel

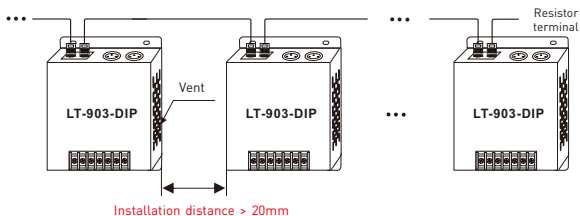

Rj45 connected in parallel

These 2 terminals can be connected in a mixed way.

- * **Installation attentions:** please reserve enough ventilation distance between decoders (>20mm), be sure not to block the vent, or it will affect lifetime of decoder for poor heat dissipation.

Attentions

1. Products shall be installed by qualified professionals.
 2. LTECH products are non-waterproof (special models excepted). Please avoid the sun and rain. When installed outdoors, please ensure it is mounted in a water proof enclosure.
 3. Good heat dissipation will extend the working life of products. Please ensure good ventilation.
 4. Please check if the working voltage used complies with the parameter requirements of products.
 5. The diameter of wire used must be able to load the light fixtures you connect and ensure the firm wiring.
 6. Before you power on products, please make sure all the wiring is correct in case of incorrect connection that causes damage to light fixtures.
 7. If a fault occurs, please do not attempt to fix products by yourself. If you have any question, please contact your suppliers.
- * This manual is subject to changes without further notice. Product functions depend on the goods. Please feel free to contact our official distributors if you have any question.

Warranty agreement

Warranty periods from the date of delivery : 5 years.

Free repair or replacement services for quality problems are provided within warranty periods.

Warranty exclusions below:

- Beyond warranty periods.
 - Any artificial damage caused by high voltage, overload, or improper operations.
 - Products with severe physical damage.
 - Damage caused by natural disasters and force majeure.
 - Warranty labels and barcodes have been damaged.
 - No any contract signed by LTECH.
1. Repair or replacement provided is the only remedy for customers. LTECH is not liable for any incidental or consequential damage unless it is within the law.
 2. LTECH has the right to amend or adjust the terms of this warranty, and release in written form shall prevail.