

## Intelligent LED Driver (Constant Voltage)

- Small size and light weight. The housing is made from V0 flame retardant PC materials that SAMSUNG/COVESTRO uses.
- The clamshell design and screwless type for strain-relief. The design of dismountable end cap allows you to adjust the length of housing depending on your needs.
- With soft-on and fade-in dimming function, enhancing your visual comfort.
- Dimming from 0~100%, down to 0.1%.
- Support Leading edge (Triac), Trailing edge (ELV) and Push DIM.
- Energy-efficient driver: Efficiency 87%, PF>0.98, THD<5%.
- The secure and reliable design for signal isolation.
- Innovative thermal management technology intelligently protects the power life.
- Overheat, over voltage, overload, short circuit protection and automatic recovery.
- Suitable for indoor light applications of I/II/III type.
- Up to 50,000-hour life time.
- 5-year warranty (Rubycon capacitor).

Flicker-free  
IEEE 1789

Dimmable:  
0.1%~100%



Use only within an enclosure. The certification icon represents on-going certification applications only, and final certification qualification is subject to actual products.

## Technical Specs

Model	LM-60-24-L1T2	LM-60-12-L1T2		
OUTPUT	Output Voltage	24Vdc	12Vdc	
	Output Voltage Range	24Vdc±0.5Vdc	12Vdc±0.5Vdc	
	Output Current	Max. 2.5A	Max. 5A	
	Output Power	Max. 60W		
	Output Power Range	0-60W		
	Strobe Level	High frequency exemption level		
	Dimming Range	0~100%, down to 0.1%		
	Overload Power Limitation	≥102%		
	Ripple	≤0.25V	≤0.5V	
	PWM Frequency	3600Hz		
INPUT	Dimming Interface	Triac/ELV, Push DIM		
	Input Voltage	108-132Vac		
	Frequency	50/60Hz		
	Input Current	≤0.67A/120Vac		
	Power Factor	PF>0.98/120Vac (at full load)		
	THD	THD<5%/120Vac (at full load)		
	Efficiency (typ.)	87%	86%	
	Standby Power Loss	<0.5W		
	Inrush Current	Cold start 25A/120Vac (Test twidth=340us under 50% Ipeak)		
	Anti Surge	L-N: 2KV		
Leakage Current	Max. 0.5mA			
ENVIRONMENT	Working Temperature	ta: -20~50°C tc: 85°C		
	Working Humidity	20-95%RH, non-condensing		
	Storage Temperature, Humidity	-40~80°C, 10-95%RH		
	Temperature Coefficient	±0.03%/°C (-20~50°C)		
	Vibration	10~500Hz, 2G 12min/1cycle, 72 min for X, Y and Z axes respectively		
PROTECTION	Overheat Protection	Intelligently adjust or turn off the output current if the PCB temperature ≥110°C, and recover automatically		
	Overload Protection	Shut down the output when current load>102%, and recover automatically		
	Short Circuit Protection	Enter hiccup mode if short circuit occurs, and recover automatically		
	Overvoltage Protection	Shut down the output when non-load voltage>26V, and recover automatically	Shut down the output when non-load voltage>13V, and recover automatically	
SAFETY & EMC	Withstand Voltage	I/P-O/P: 3750Vac		
	Isolation Resistance	I/P-O/P: 100MΩ/500VDC/25°C/70%RH		
	Safety Standards	UL	America	UL8750
		CUL	Canada	CSA C22.2 NO. 250. 13
		CE	European Union	EN61347-1, EN61347-2-13, EN62384
	EMC Emission	UL	America	FCC part 15
		CE	European Union	EN55015, EN61000-3-2, EN61000-3-3, EN61547
EMC Immunity	EN61000-4-2,3,4,5,6,8,11, EN61547			
Strobe Test Standard	IEEE 1789			
OTHERS	Gross Weight(G.W)	360g±10g		
	Dimensions	293×43×30mm(L×W×H)		
	Package Size	296×44×33mm(L×W×H)		
	Outer Box Specifications	315×230×215mm(L×W×H) 30pcs/ctn 11.6kg±5%/ctn		

The driver is suitable for connecting resistor current-limiting LED fixture (e.g. LED strip). The inrush current will be dozens of times increased if connecting built-in constant current IC current-limiting LED fixtures, the driver will activate the overloaded protection (hiccup flickering). When you order, please remark controlling the constant current LED fixture (e.g. MR16 lamp, underground light, LED wall washer, constant current LED strip, etc.), so that we can prepare them with special procedures.

## Product Size

Unit: mm

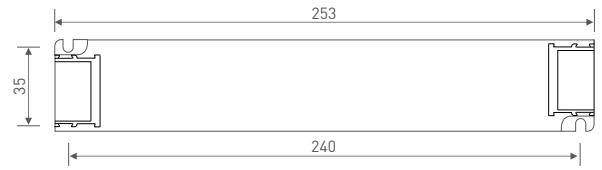
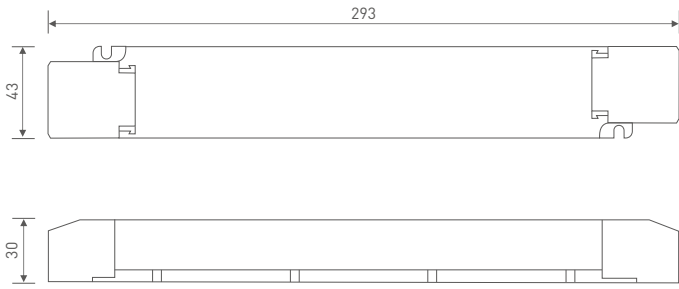

## Wiring Diagram

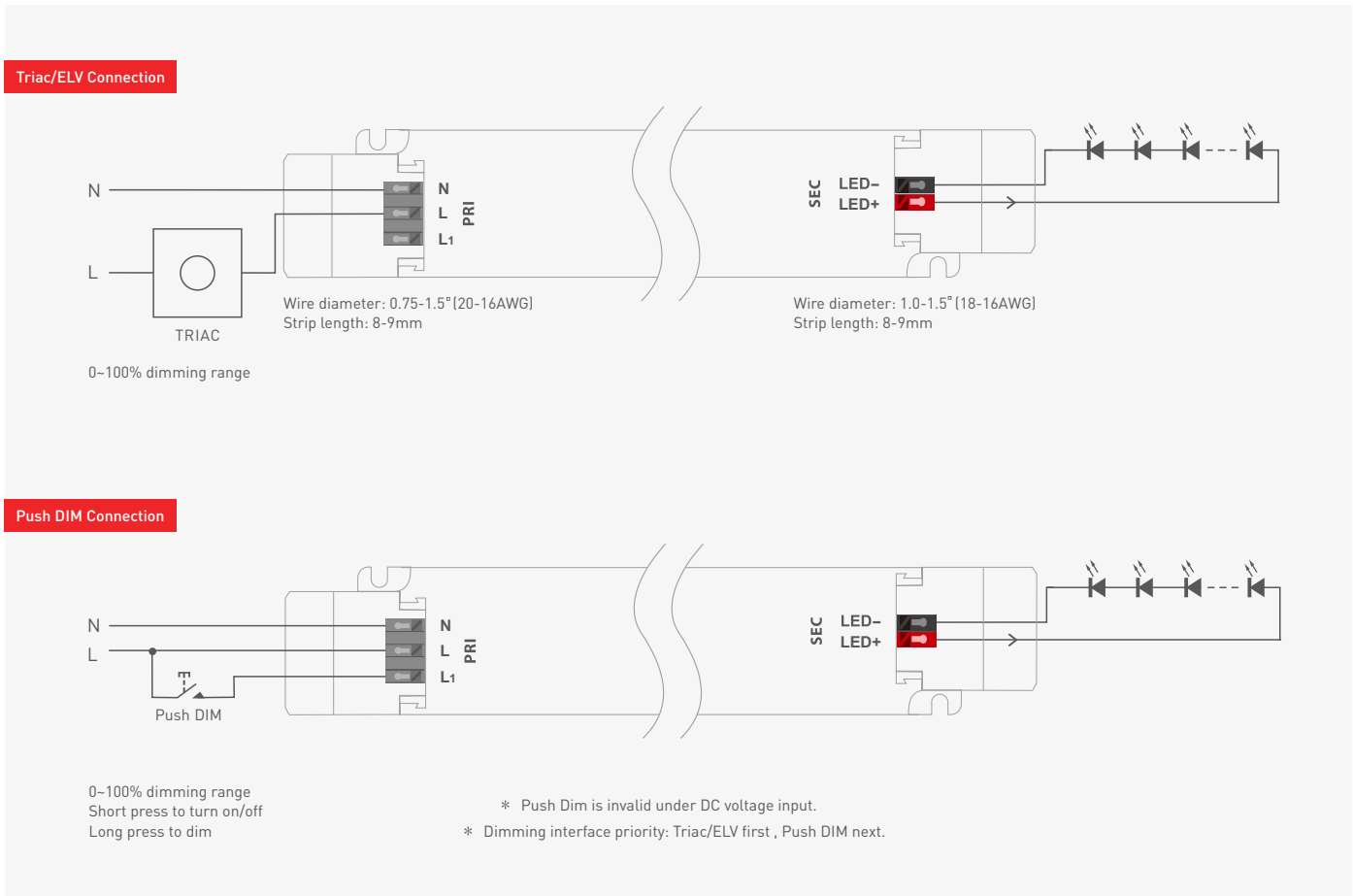

## Push DIM



Reset switch

- On/off control: Short press.
- Stepless dimming: Long press.
- With every other long press, the brightness level goes to the opposite direction.
- Dimming memory: Dimming memory: Short press the PUSH DIM button, the brightness will go to the the previously adjusted level.  
Power on again after power cut, the output brightness will be adjusted in accordance with the input voltage of drivers.

## Protective Housing Application Diagram

### Tension plate

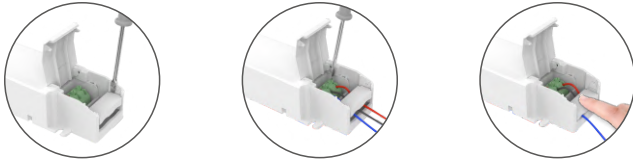

1. Pry up the protecting housing in the side plate position with a tool.
2. Connect to electrical wires with a screwdriver as wiring diagram shows.
3. Press down the tension plate to fix the the electrical wires, then close the protective housing.

### Remove the protective housing



Pull the housing left and right from the bottom to remove it.

## Installation Precautions

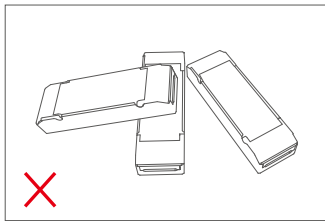

Please do not stack the products. The distance between two products should be  $\geq 15\text{cm}$  so as not to affect heat dissipation and the lifespan of the products.

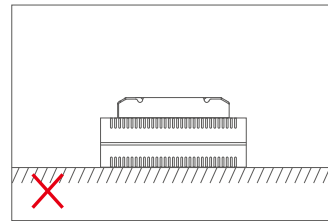
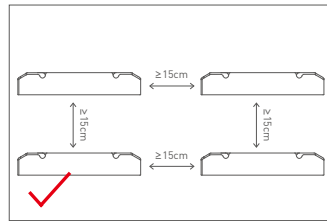

Please not place the products on LED drivers. The distance between the product and the driver should be  $\geq 15\text{cm}$  so as not to affect heat dissipation and shorten the lifespan of the products.

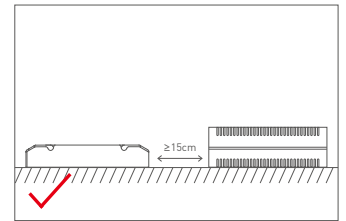

## Relationship Diagrams

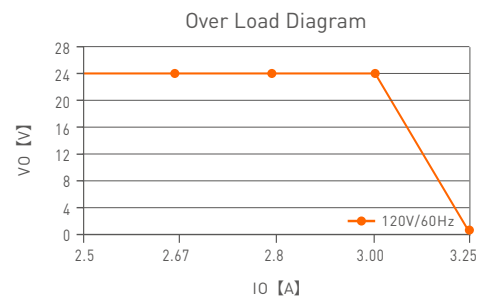
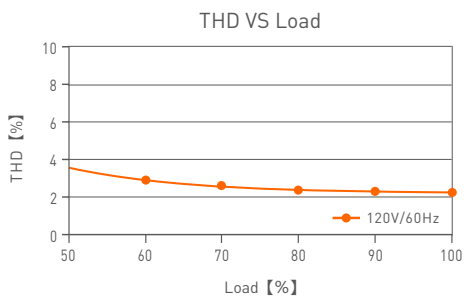
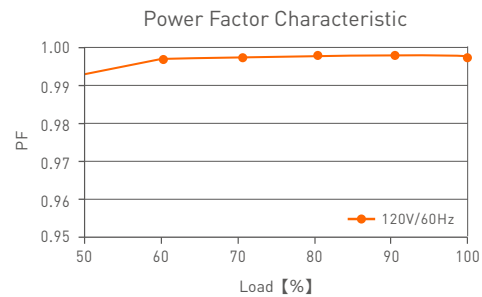
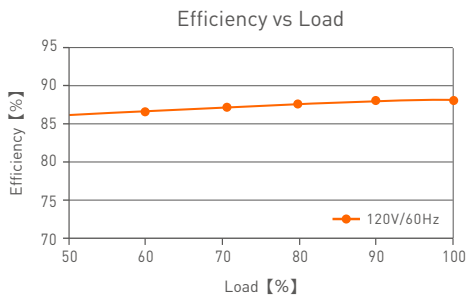

LM-60-24-L1T2

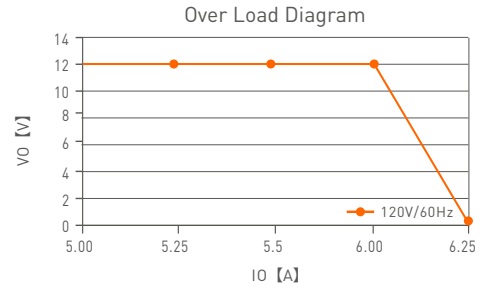
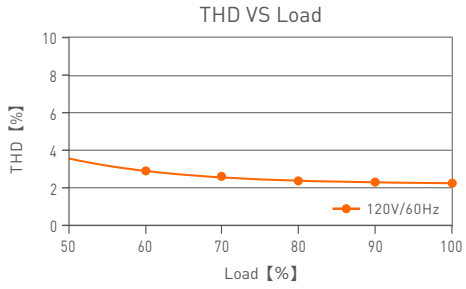
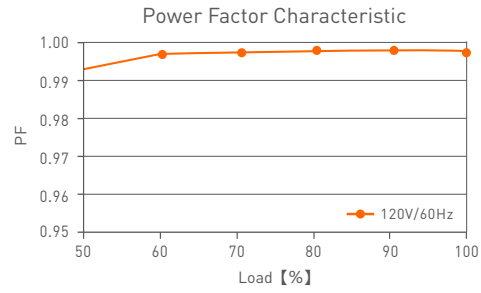
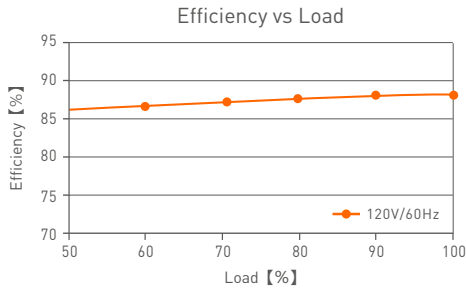

LM-60-12-L1T2

## Flicker Test Table

Limit Value of Modulation in Low Risk Areas	
Waveform frequency of Optical output (f)	Limit value (%)
$f \leq 8\text{Hz}$	0.2
$8\text{Hz} < f \leq 90\text{Hz}$	$0.025 \times f$
$90\text{Hz} < f \leq 1250\text{Hz}$	$0.08 \times f$
$f > 1250\text{Hz}$	Exemption assessment
Limit Value of Modulation in No Effect Areas	
Waveform frequency of Optical output (f)	Limit value (%)
$f \leq 10\text{Hz}$	0.1
$10\text{Hz} < f \leq 90\text{Hz}$	$0.01 \times f$
$90\text{Hz} < f \leq 3125\text{Hz}$	$[0.08/2.5] \times f$
$f > 3125\text{Hz}$	Exemption assessment (High frequency exemption)

- Brightness
- ▲ 0.1%
  - ◆ 1%
  - ◆ 5%
  - ◆ 10%
  - 20%
  - ▲ 30%
  - 40%
  - ★ 50%
  - 60%
  - 70%
  - 80%
  - ★ 90%
  - ◆ 100%

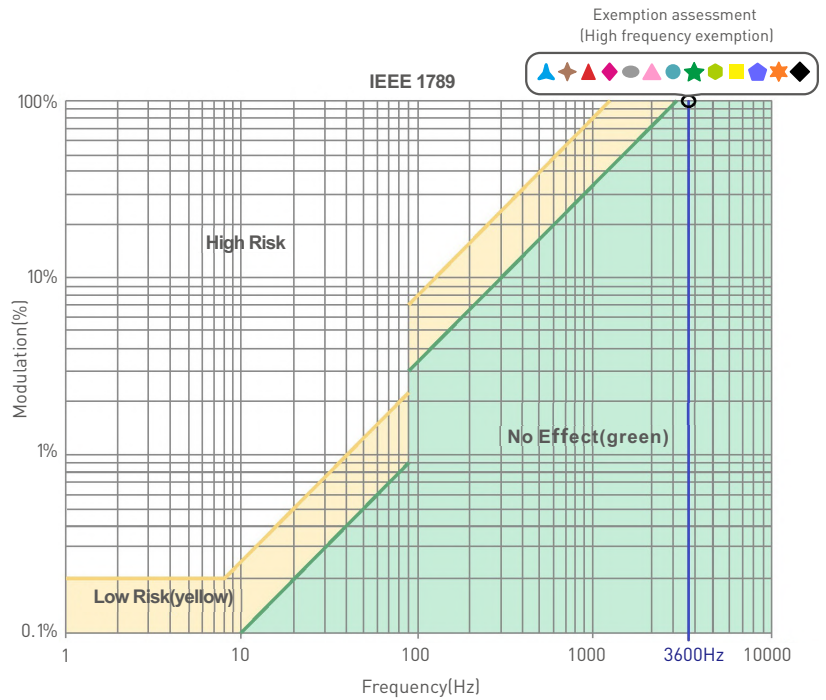

Marks in the right chart are tested results of different current levels. The output frequency is 0Hz in 100% brightness and its corresponding modulation is 0%, which could not be shown in the right chart.

## Attentions

- Products shall be installed by qualified professionals.
- LTECH products are non-waterproof (special models excepted). Please avoid the sun and rain. When installed outdoors, please ensure it is mounted in a water proof enclosure.
- Good heat dissipation will extend the working life of products. Please ensure good ventilation.
- Please check if the working voltage used complies with the parameter requirements of products.
- The diameter of wire used must be able to load the light fixtures you connect and ensure the firm wiring.
- Before you power on products, please make sure all the wiring is correct in case of incorrect connection that causes damage to light fixtures.
- If a fault occurs, please do not attempt to fix products by yourself. If you have any question, please contact your suppliers.

\* This manual is subject to changes without further notice. Product functions depend on the goods. Please feel free to contact our official distributors if you have any question.

## Warranty Agreement

- Warranty periods from the date of delivery: 5 years.
- Free repair or replacement services for quality problems are provided within warranty periods.

Warranty exclusions below:

- Beyond warranty periods.
- Any artificial damage caused by high voltage, overload, or improper operations.
- Products with severe physical damage.
- Damage caused by natural disasters and force majeure.
- Warranty labels and barcodes have been damaged.
- No any contract signed by LTECH.

1. Repair or replacement provided is the only remedy for customers. LTECH is not liable for any incidental or consequential damage unless it is within the law.
2. LTECH has the right to amend or adjust the terms of this warranty, and release in written form shall prevail.

## Update Log

Version	Updated Time	Update Content	Updated by
A0	2021.03.29	Original version	Liu Weili
A1	2021.12.10	Update product silk screen	Liu Weili